

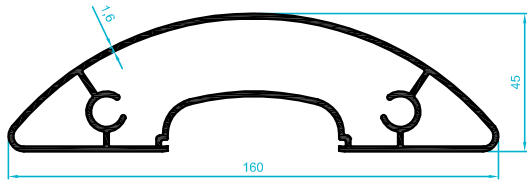

**FURNITURE AND
DECORATION PROFILES**





201.71
2,005 kg/m

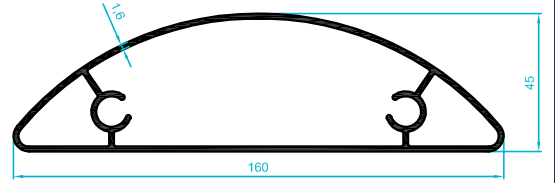

201.70
1,892 kg/m

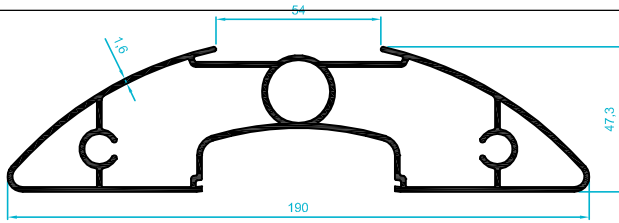

201.44
2,602 kg/m

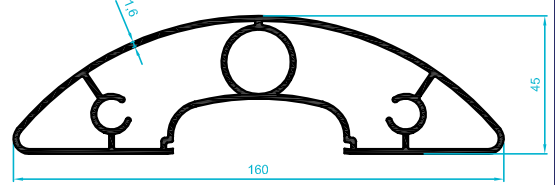

201.72
2,285 kg/m

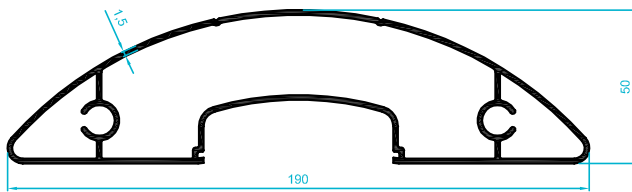

201.144
2,197 kg/m

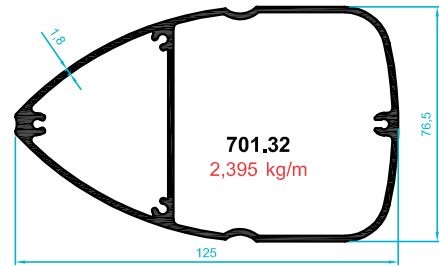

701.32
2,395 kg/m

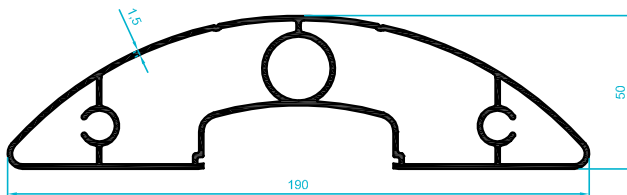

201.142
2,473 kg/m

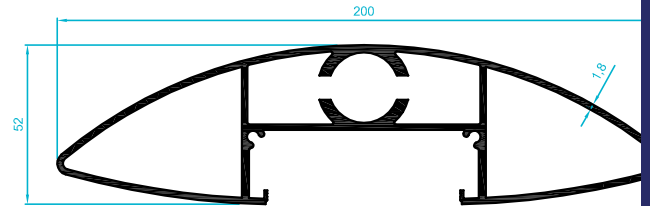

705.02
3,072 kg/m

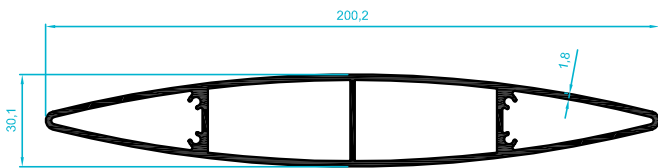

705.01
2,724 kg/m

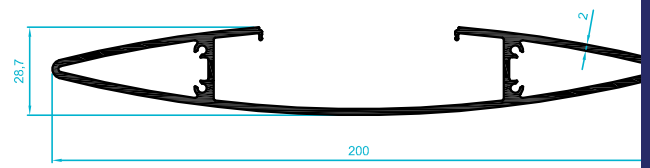

705.03
2,218 kg/m

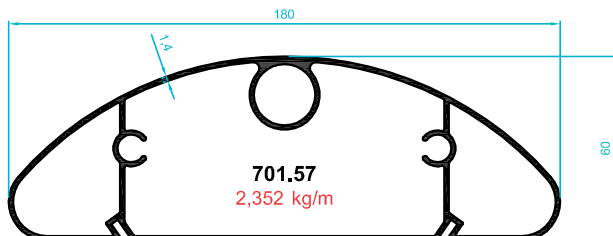

701.57
2,352 kg/m

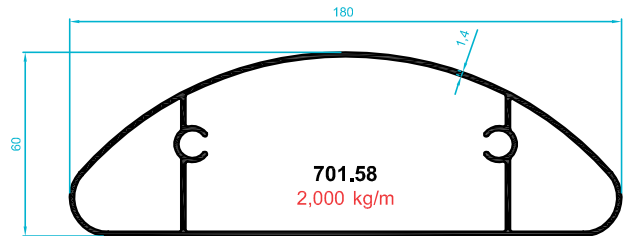

701.58
2,000 kg/m

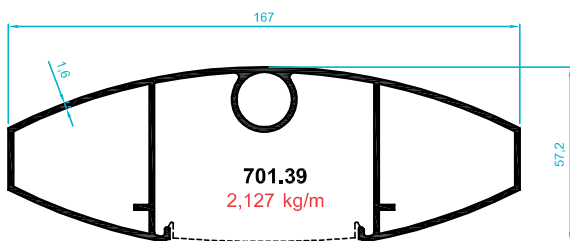

701.39
2,127 kg/m

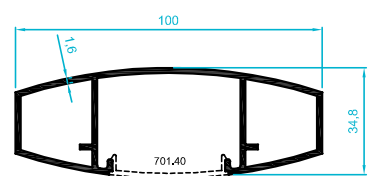

701.41
1,182 kg/m



701.38
0,363 kg/m

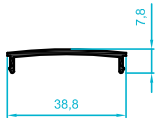

701.40
0,257 kg/m

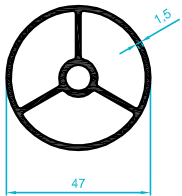

204.42
0,958 kg/m

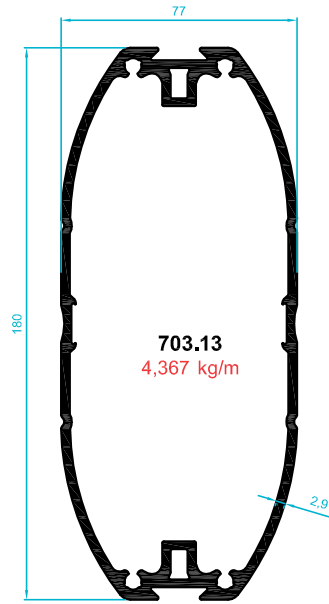

703.13
4,367 kg/m

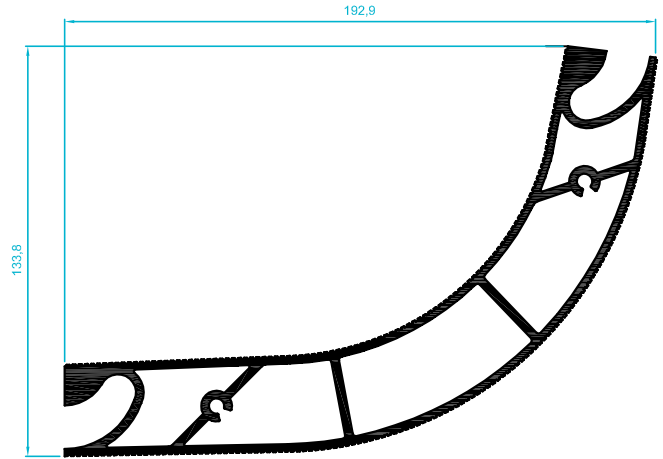

701.49
5,117 kg/m

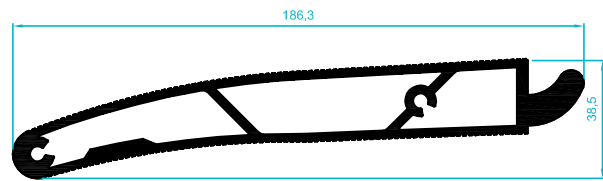

701.47
3,528 kg/m

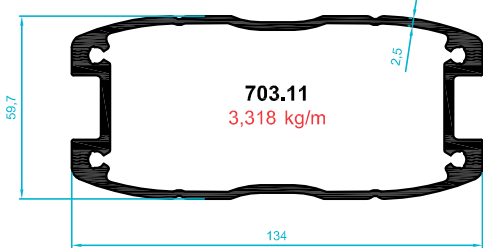

703.11
3,318 kg/m

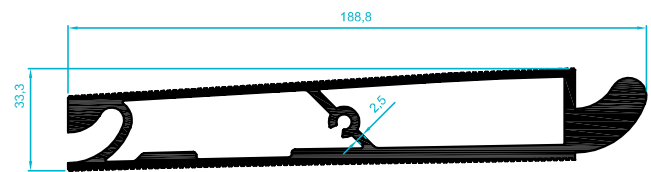

701.48
4,607 kg/m

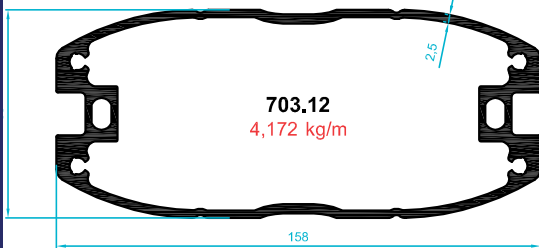

703.12
4,172 kg/m

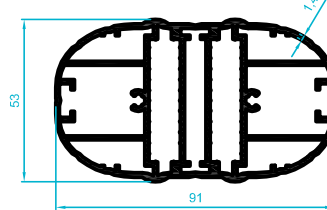

207.123
2,382 kg/m

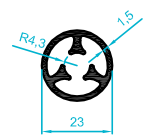

204.45
0,420 kg/m

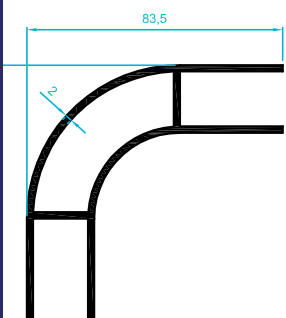

701.43
1,585 kg/m

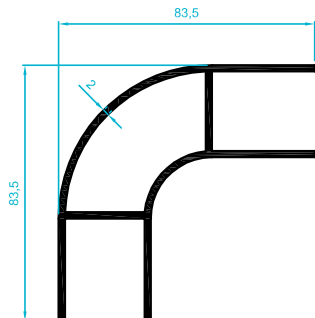

701.44
1,604 kg/m

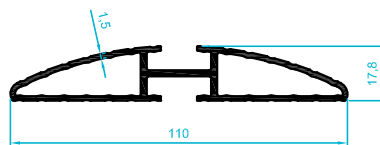

207.14
1,102 kg/m

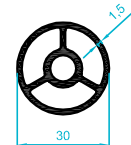

204.43
0,640 kg/m

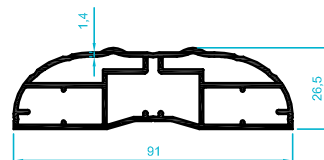



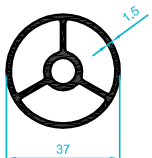



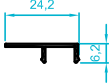
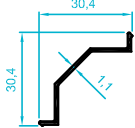
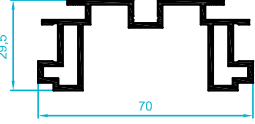
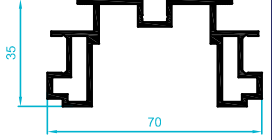
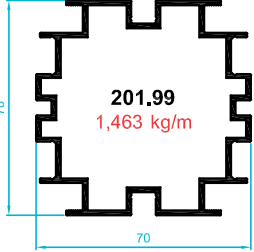
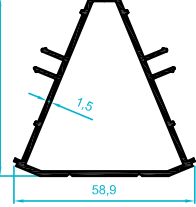
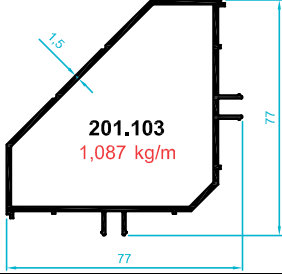
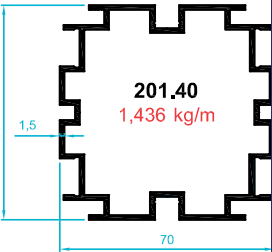

207.15
1,295 kg/m

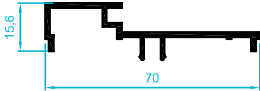
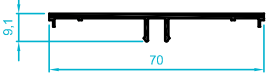

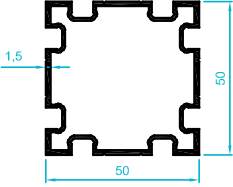
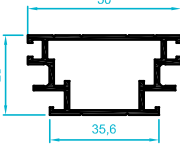
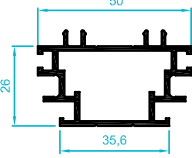
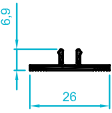
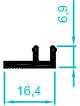
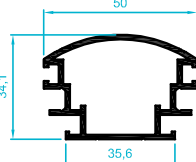
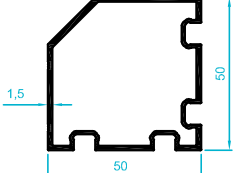

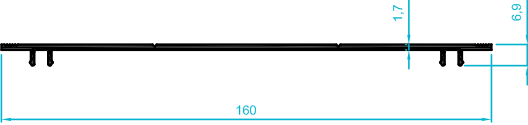





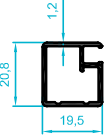
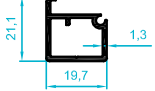
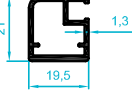

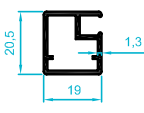
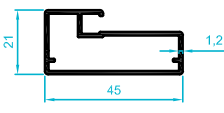
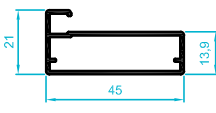
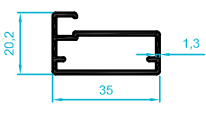

204.44
0,770 kg/m

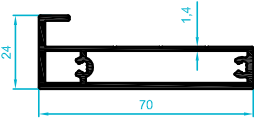
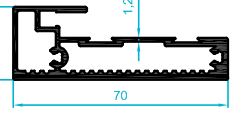



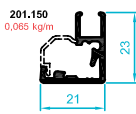
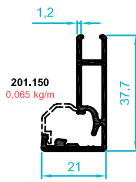
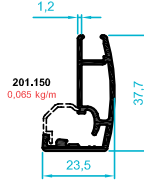
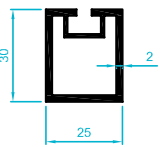
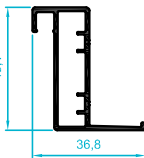
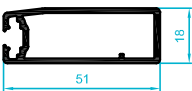
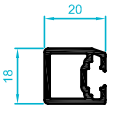
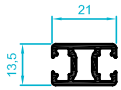
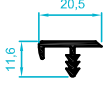

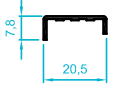
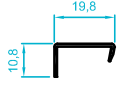
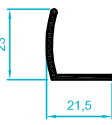

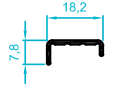
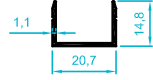
Ofis Bölme Profilleri

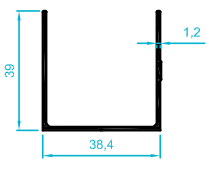
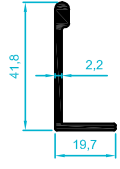
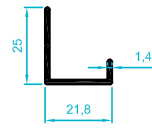
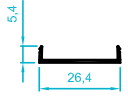
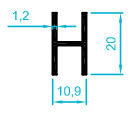
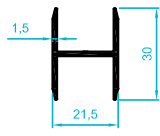
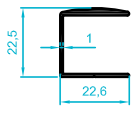
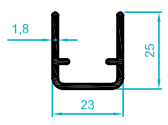
 <p>201.100 0,101 kg/m</p>	 <p>201.102 0,154 kg/m</p>	 <p>201.38 1,120 kg/m</p>	 <p>201.101 0,993 kg/m</p>
 <p>201.99 1,463 kg/m</p>	 <p>201.128 0,856 kg/m</p>	 <p>201.103 1,087 kg/m</p>	 <p>201.40 1,436 kg/m</p>
 <p>201.41 0,206 kg/m</p>	 <p>201.43 0,461 kg/m</p>	 <p>201.39 0,342 kg/m</p>	 <p>201.42 0,086 kg/m</p>
 <p>209.53 0,897 kg/m</p>	 <p>209.52 0,702 kg/m</p>	 <p>209.55 0,764 kg/m</p>	 <p>209.50 0,144 kg/m</p>
 <p>209.51 0,100 kg/m</p>	 <p>209.72 0,759 kg/m</p>	 <p>209.62 0,821 kg/m</p>	 <p>209.49 0,588 kg/m</p>
 <p>209.54 0,786 kg/m</p>		 <p>209.61 0,489 kg/m</p>	

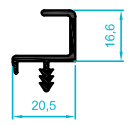
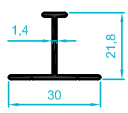
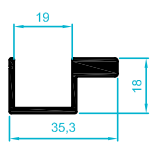
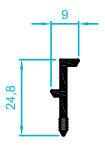
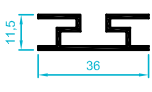
Mobilya Kapak Profilleri

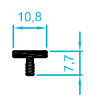
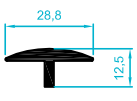
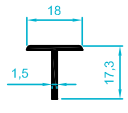
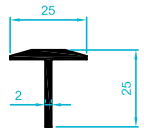
 <p>201.121 0,265 kg/m</p>	 <p>201.110 0,286 kg/m</p>	 <p>201.108 0,266 kg/m</p>	 <p>201.12 0,324 kg/m</p>
--	--	---	---

 <p>201.49 0,295 kg/m</p>	 <p>201.07 0,450 kg/m</p>	 <p>201.09 0,425 kg/m</p>	 <p>201.22 0,395 kg/m</p>
 <p>201.124 0,499 kg/m</p>	 <p>201.125 0,385 kg/m</p>	 <p>201.30 0,621 kg/m</p>	 <p>201.123 1,123 kg/m</p>
 <p>201.112 1,093 kg/m</p>	 <p>201.146 0,403 kg/m</p>	 <p>201.151 0,336 kg/m</p>	 <p>201.170 0,344 kg/m</p>
 <p>201.147 0,292 kg/m</p>	 <p>201.149 0,399 kg/m</p>	 <p>201.148 0,437 kg/m</p>	 <p>701.42 0,593 kg/m</p>
 <p>201.52 0,469 kg/m</p>	 <p>201.59 0,615 kg/m</p>	 <p>201.60 0,350 kg/m</p>	 <p>201.61 0,295 kg/m</p>
Sunta Kenar ve Süs Profilleri			
 <p>201.47 0,165 kg/m</p>	 <p>201.58 0,127 kg/m</p>	 <p>201.81 0,095 kg/m</p>	 <p>201.80 0,095 kg/m</p>
 <p>201.35 0,183 kg/m</p>	 <p>201.137 0,089 kg/m</p>	 <p>201.138 0,084 kg/m</p>	 <p>201.157 0,136 kg/m</p>

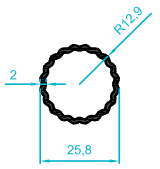
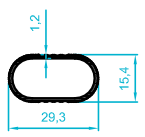
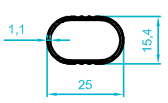
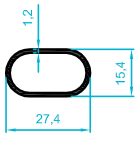
 <p>211.31 0,377 kg/m</p>	 <p>209.87 0,398 kg/m</p>	 <p>209.92 0,195 kg/m</p>	 <p>211.24 0,089 kg/m</p>
 <p>201.154 0,154 kg/m</p>	 <p>201.155 0,306 kg/m</p>	 <p>201.21 0,235 kg/m</p>	 <p>201.26 0,345 kg/m</p>
 <p>201.166 0,117 kg/m</p>	 <p>201.46 0,279 kg/m</p>	 <p>209.91 0,214 kg/m</p>	 <p>209.90 0,447 kg/m</p>
 <p>701.67 0,165 kg/m</p>	 <p>209.89 0,309 kg/m</p>	 <p>201.115 0,737 kg/m</p>	 <p>201.114 0,350 kg/m</p>
 <p>345.13 0,088 kg/m</p>	 <p>602.16 0,049 kg/m</p>	 <p>211.17 0,126 kg/m</p>	 <p>504.44 0,285 kg/m</p>
 <p>209.99 0,079 kg/m</p>	 <p>209.100 0,092 kg/m</p>	 <p>211.19 0,265 kg/m</p>	 <p>709.82 0,290 kg/m</p>
 <p>201.16 0,211 kg/m</p>	 <p>201.17 0,170 kg/m</p>	 <p>605.14 0,223 kg/m</p>	

Sürme Kapak ve Ray Profilleri

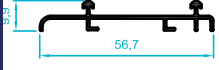

201.06
0,270 kg/m



201.24
0,276 kg/m



201.15
0,233 kg/m

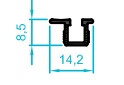

201.56
0,091 kg/m

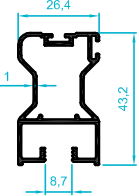

201.10
0,527 kg/m

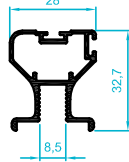

201.11
0,438 kg/m

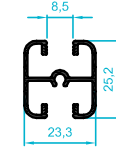

201.13
0,322 kg/m

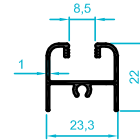

201.14
0,258 kg/m

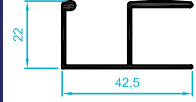

201.57
0,350 kg/m

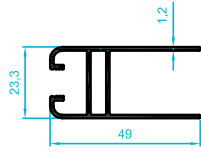

201.08
0,509 kg/m

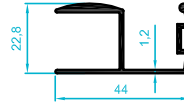

201.25
0,442 kg/m

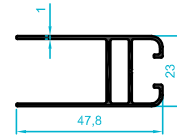

201.89
0,427 kg/m

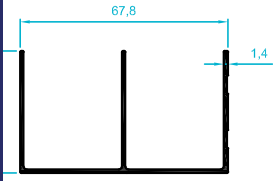

201.05
0,571 kg/m

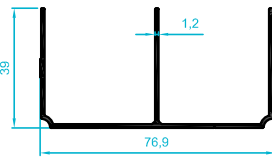

201.85
0,621 kg/m

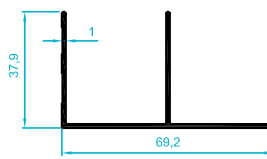

201.91
0,552 kg/m

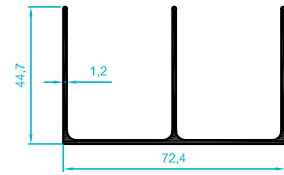

201.130
0,680 kg/m

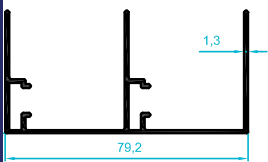

201.109
0,756 kg/m

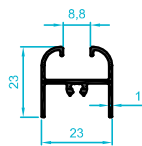

201.111
0,263 kg/m

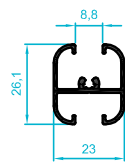

201.90
0,308 kg/m

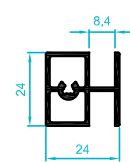

201.113
0,427 kg/m

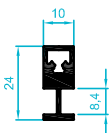

201.119
0,333 kg/m

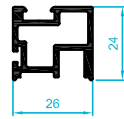

201.118
0,521 kg/m



201.122
0,070 kg/m

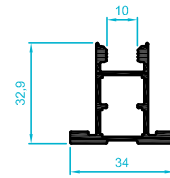

201.153
0,583 kg/m



201.120
0,281 kg/m

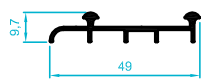



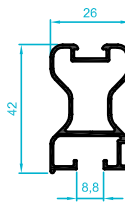







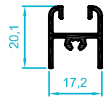
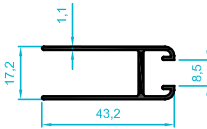
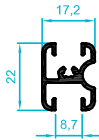
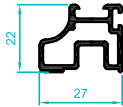
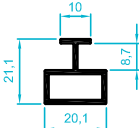
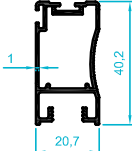
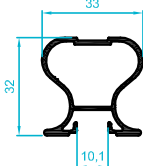

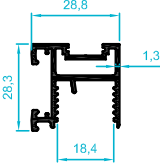
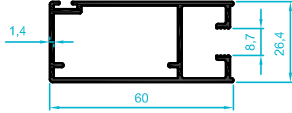
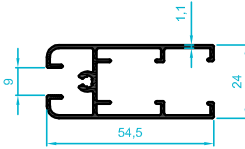
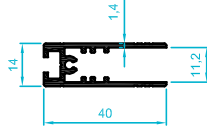
201.116
0,318 kg/m

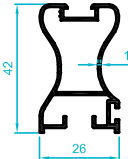
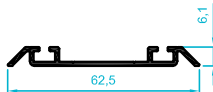

201.88
0,495 kg/m

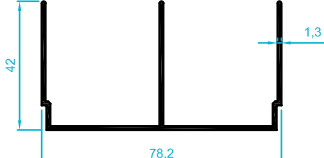

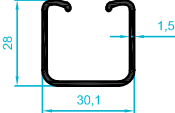
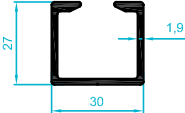
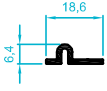
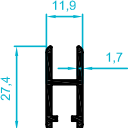
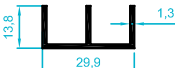
201.87
0,436 kg/m

 <p>201.65 0,236 kg/m</p>	 <p>201.64 0,355 kg/m</p>	 <p>201.66 0,279 kg/m</p>	 <p>201.67 0,390 kg/m</p>
 <p>201.31 0,267 kg/m</p>	 <p>201.160 0,444 kg/m</p>	 <p>209.13 0,453 kg/m</p>	 <p>209.14 0,455 kg/m</p>
 <p>201.98 0,495 kg/m</p>	 <p>201.164 0,753 kg/m</p>	 <p>201.165 0,577 kg/m</p>	 <p>201.169 0,453 kg/m</p>
 <p>201.159 0,274 kg/m</p>	 <p>209.67 0,466 kg/m</p>	 <p>209.09 0,322 kg/m</p>	 <p>209.10 0,539 kg/m</p>
 <p>209.11 0,265 kg/m</p>	 <p>209.12 0,249 kg/m</p>	 <p>209.08 0,678 kg/m</p>	 <p>209.93 0,127 kg/m</p>
 <p>201.23 0,126 kg/m</p>	 <p>201.18 0,380 kg/m</p>	 <p>201.94 0,520 kg/m</p>	 <p>201.167 0,103 kg/m</p>
 <p>201.19 0,297 kg/m</p>	 <p>201.20 0,237 kg/m</p>	 <p>201.37 0,526 kg/m</p>	

Kulp Profilleri

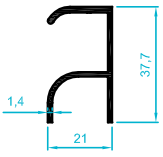

201.156
0,360 kg/m

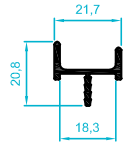

201.32
0,213 kg/m



201.36
0,340 kg/m

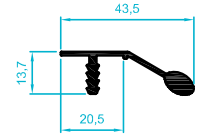

209.88
0,371 kg/m

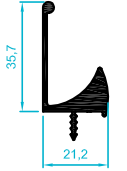

201.158
0,507 kg/m

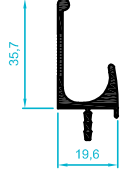

201.161
0,436 kg/m

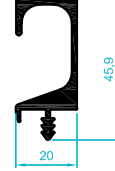

211.13
0,665 kg/m

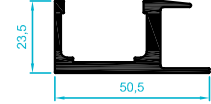

211.14
0,845 kg/m

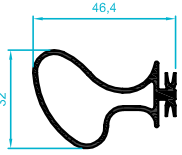

701.46
0,545 kg/m



211.20
0,305 kg/m

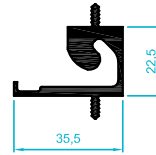

212.28
0,856 kg/m



212.29
0,575 kg/m

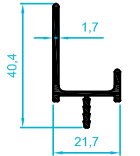

201.33
0,302 kg/m

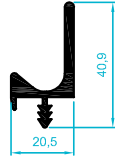

201.48
0,518 kg/m

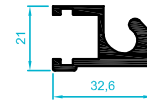

212.30
0,637 kg/m

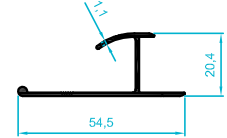

207.96
0,285 kg/m

Ayarlanabilir Kapı Kasası ve Ofis Bölme Profilleri

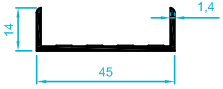

212.18
0,285 kg/m

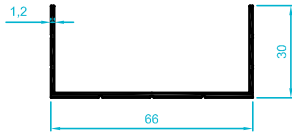

212.10
0,463 kg/m

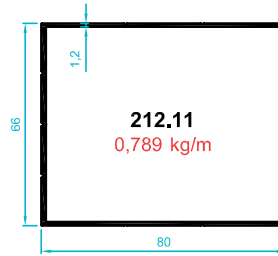

212.11
0,789 kg/m

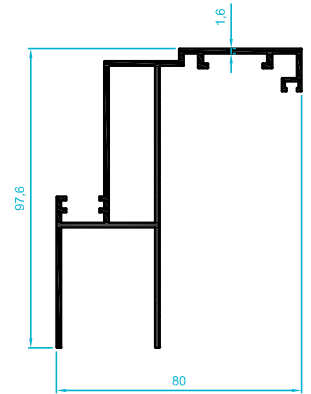

212.12
1,691 kg/m

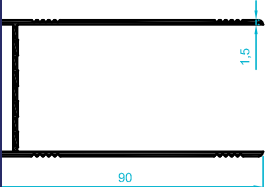

212.23
1,065 kg/m

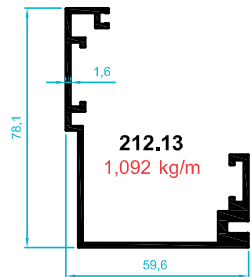

212.13
1,092 kg/m

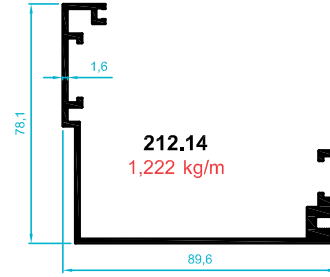

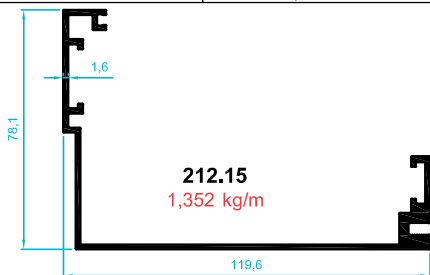

212.14
1,222 kg/m

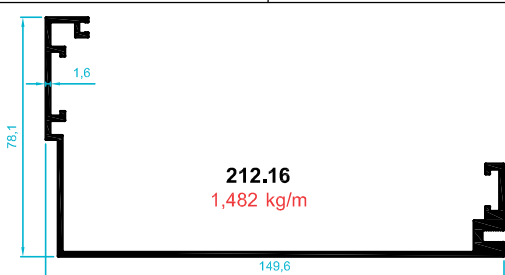

212.15
1,352 kg/m

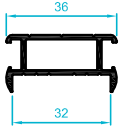
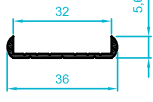
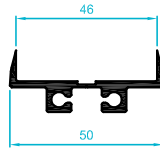
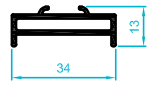
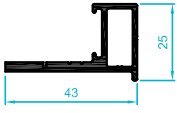
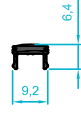
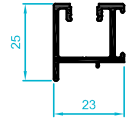
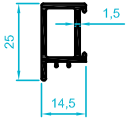
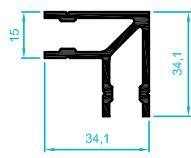
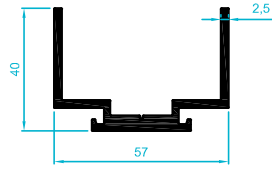
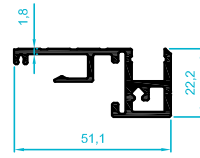
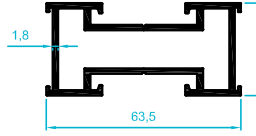
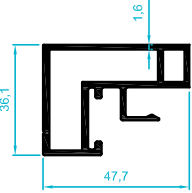
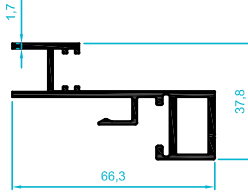
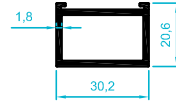

212.16
1,482 kg/m

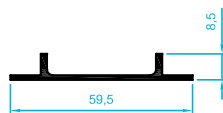
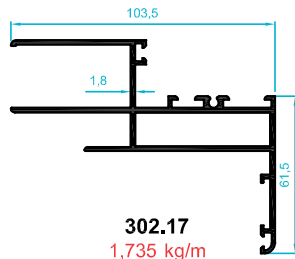
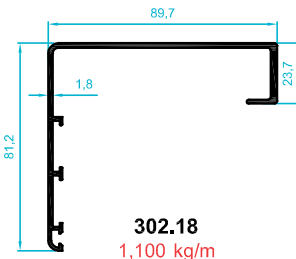
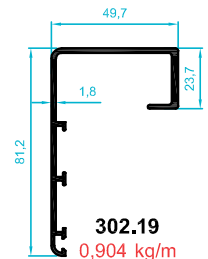
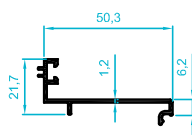
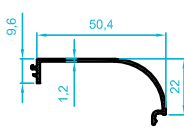
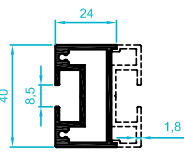
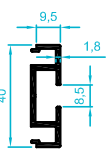
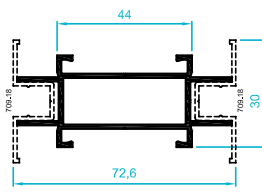
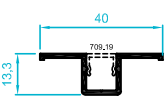
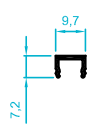
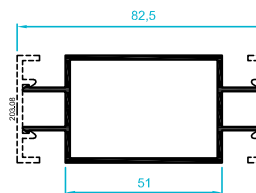
 <p>212.19 0,423 kg/m</p>	 <p>212.20 0,168 kg/m</p>	 <p>212.21 0,539 kg/m</p>	 <p>212.22 0,358 kg/m</p>
 <p>212.26 0,542 kg/m</p>	 <p>212.27 0,068 kg/m</p>	 <p>212.24 0,347 kg/m</p>	 <p>212.25 0,287 kg/m</p>
 <p>212.17 0,718 kg/m</p>	 <p>212.01 1,068 kg/m</p>	 <p>212.02 0,683 kg/m</p>	 <p>212.03 1,135 kg/m</p>
 <p>212.05 0,970 kg/m</p>	 <p>212.06 0,892 kg/m</p>	 <p>212.07 0,466 kg/m</p>	 <p>212.09 0,718 kg/m</p>
 <p>212.08 0,320 kg/m</p>	 <p>302.17 1,735 kg/m</p>	 <p>302.18 1,100 kg/m</p>	 <p>302.19 0,904 kg/m</p>
 <p>302.20 0,253 kg/m</p>	 <p>302.21 0,319 kg/m</p>	<p>8 - 20 mm Arasında Cam Kullanılabilir</p>  <p>302.22 0,783 kg/m</p>	<p>8 - 20 mm Arasında Cam Kullanılabilir</p>  <p>302.23 0,413 kg/m</p>
 <p>709.17 0,770 kg/m</p>	 <p>709.18 0,230 kg/m</p>	 <p>709.19 0,060 kg/m</p>	 <p>203.07 0,818 kg/m</p>

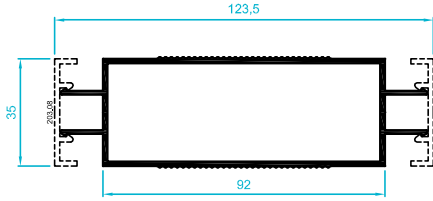

203.33
1,279 kg/m

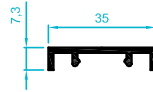

203.08
0,255 kg/m

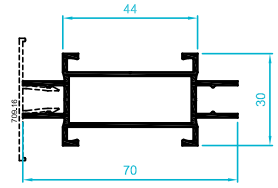

709.10
0,780 kg/m

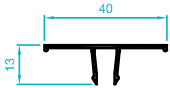

709.16
0,187 kg/m

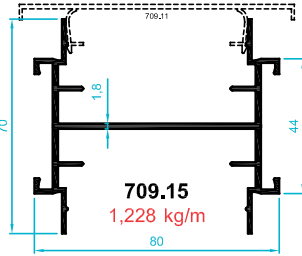

709.15
1,228 kg/m

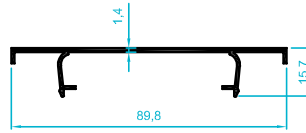

709.11
0,469 kg/m

Lambiri ve Griyaj Profilleri



311.17
0,516 kg/m



312.01
0,530 kg/m

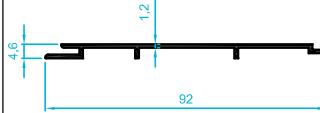

312.02
0,357 kg/m

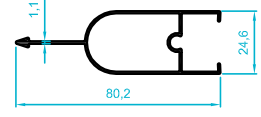

321.11
0,478 kg/m

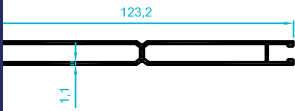

321.15
0,831 kg/m

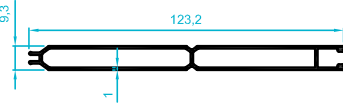

321.46
0,729 kg/m

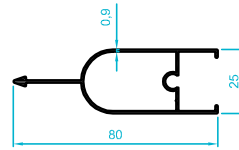

323.15
0,467 kg/m

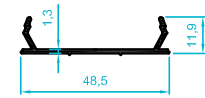

207.04
0,252 kg/m

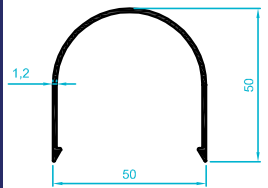

207.03
0,425 kg/m

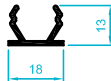

207.06
0,165 kg/m

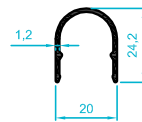

207.05
0,195 kg/m

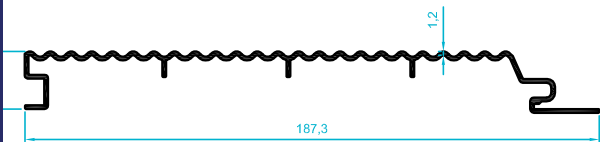

207.09
1,391 kg/m





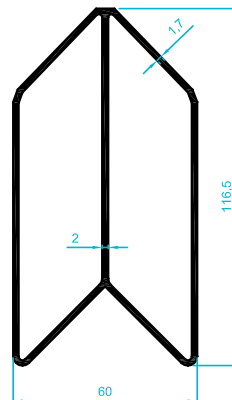





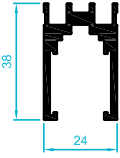

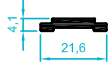
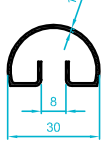
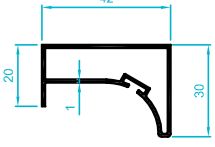
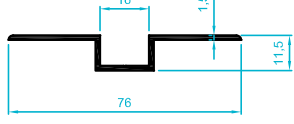
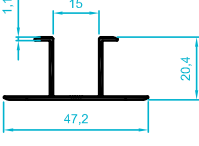
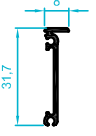
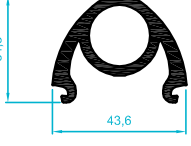

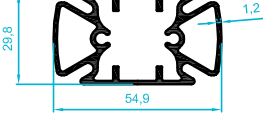
401.06
0,919 kg/m

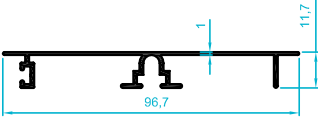
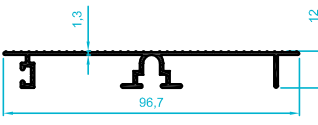
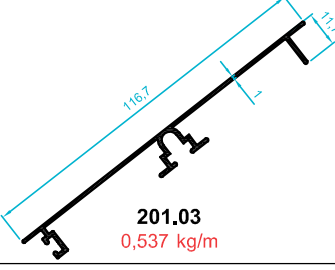
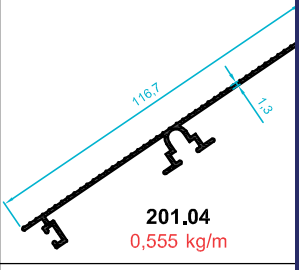
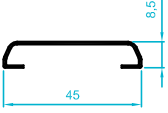
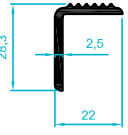

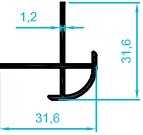
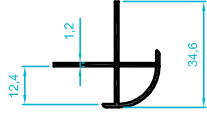
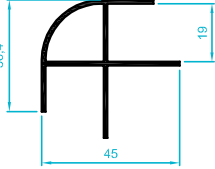
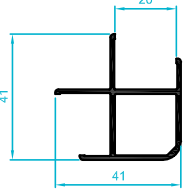
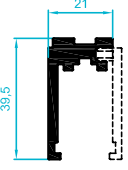
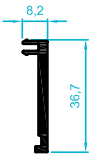
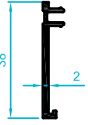
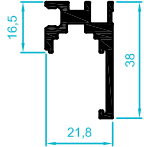
309.25
2,014 kg/m

Diger Profiller

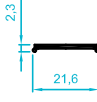
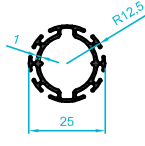
 <p>209.26 0,737 kg/m</p>	 <p>201.162 0,195 kg/m</p>	 <p>201.163 0,171 kg/m</p>	 <p>207.105 0,333 kg/m</p>
 <p>207.104 0,398 kg/m</p>	 <p>207.127 0,387 kg/m</p>	 <p>207.97 0,279 kg/m</p>	 <p>201.63 0,157 kg/m</p>
 <p>201.140 1,202 kg/m</p>	 <p>201.53 0,837 kg/m</p>	 <p>201.145 1,014 kg/m</p>	 <p>201.141 0,545 kg/m</p>
 <p>201.01 0,482 kg/m</p>	 <p>201.02 0,497 kg/m</p>	 <p>201.03 0,537 kg/m</p>	 <p>201.04 0,555 kg/m</p>
 <p>210.22 0,146 kg/m</p>	 <p>505.27 0,306 kg/m</p>	 <p>210.28 0,198 kg/m</p>	 <p>210.27 0,176 kg/m</p>
 <p>211.32 0,276 kg/m</p>	 <p>211.33 0,312 kg/m</p>	 <p>211.28 0,488 kg/m</p>	 <p>211.27 0,526 kg/m</p>
 <p>201.105 0,619 kg/m</p>	 <p>201.104 0,319 kg/m</p>	 <p>209.24 0,240 kg/m</p>	 <p>209.25 0,555 kg/m</p>

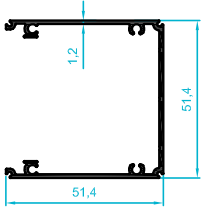
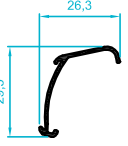
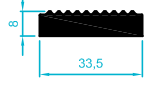
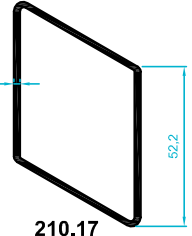
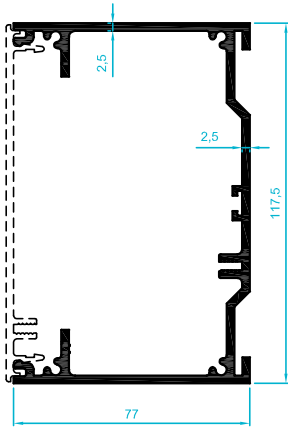
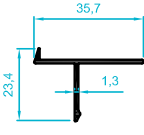
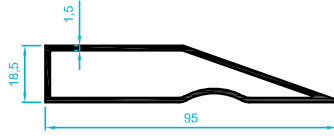
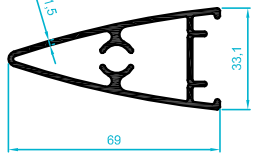
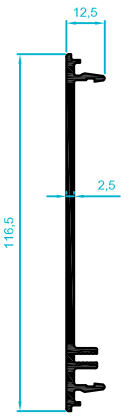
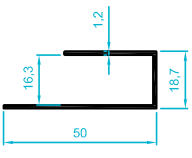
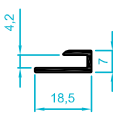
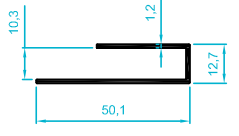
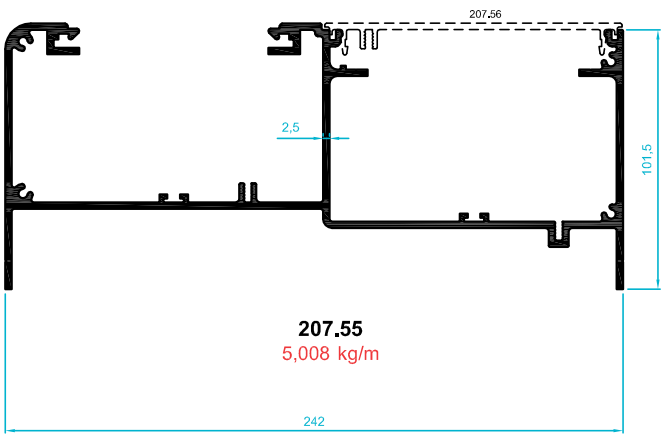
 <p>201.34 0,062 kg/m</p>	 <p>211.01 0,071 kg/m</p>	 <p>204.40 0,301 kg/m</p>	 <p>201.134 0,347 kg/m</p>
 <p>201.51 0,610 kg/m</p>	 <p>701.86 0,157 kg/m</p>	 <p>210.18 0,678 kg/m</p>	 <p>210.17 0,927 kg/m</p>
 <p>207.124 2,482 kg/m</p>	 <p>212.04 0,203 kg/m</p>	 <p>210.07 0,835 kg/m</p>	 <p>201.45 0,916 kg/m</p>
 <p>207.56 0,948 kg/m</p>	 <p>603.13 0,314 kg/m</p>	 <p>603.15 0,119 kg/m</p>	 <p>603.14 0,295 kg/m</p>
		 <p>207.55 5,008 kg/m</p>	



modern bir hayat için...



modern bir hayat için...

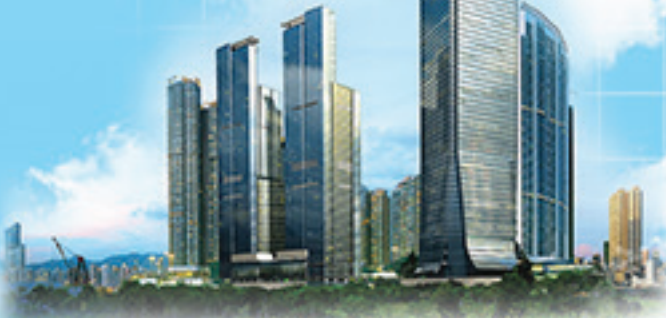

modern bir hayat için...



**FURNITURE AND
DECORATION PROFILES**

 **AFSS GLOBAL**